

Lemi[®]
ITALIAN WELLNESS EQUIPMENT



EVO



FAVORITE
TREATMENT TABLE MANUFACTURER

All EVO spa tables feature a mattress with HBS Stress Relief System. This is the innovative system by which the head, the back and the shoulders can be stimulated without stretching and contractures, thanks to the possibility of lowering the armrests and adjusting the headrest.

Tutti i lettini EVO presentano il materasso con Sistema Anti Stress HBS, si tratta dell'innovativo sistema col quale testa, schiena e braccia possono essere stimolate senza stiramenti e contratture, grazie alla possibilità di abbassare i braccioli e regolare l'appoggiatesta.

COD. 1319

A spa experience where technological innovation meets the elegance of Italian design: MILANO EVO, the spa bed that redefines luxury. Not just a work tool, but a true work of art whose curved wood and painted steel structure reflects Italian craftsmanship, while the mattress with enhanced Memory Foam powered by the Anti Stress HBS System offers unparalleled comfort. By combining the chromotherapy of the two LED strips that illuminate the environment, a unique atmosphere is created for every wellness experience. Milano Evo stands for commitment to sustainability and customization, thanks to FSC certified materials and a range of exclusive finishes. A definitive wellness experience, designed for those who seek only the best.

IDEAL FOR: massages, face and body treatments, hair removal, treatments with aesthetic equipment.

Un'esperienza spa in cui l'innovazione tecnologica incontra l'eleganza del design italiano: MILANO EVO, il lettino spa che ridefinisce il lusso. Non solo uno strumento di lavoro, ma una vera opera d'arte la cui struttura in legno curvato e acciaio verniciato rispecchia l'artigianato italiano, mentre il materasso con Memory Foam potenziato dal Sistema Anti Stress HBS offre un comfort senza eguali. Abbinando la cromoterapia delle due strisce LED che illuminano l'ambiente, si crea un'atmosfera unica per ogni esperienza di benessere. MILANO EVO significa impegno per la sostenibilità e personalizzazione, grazie ai materiali certificati FSC e a una gamma di finiture esclusive. Un'esperienza di benessere definitiva, pensata per chi cerca solo il meglio.

IDEALE PER: massaggi, trattamenti viso e corpo, depilazione, trattamenti con apparecchiature estetiche.

* The images are for illustrative purposes only and may not reflect the actual image of the finishing.

* Le immagini hanno valore puramente illustrativo e possono non rispecchiare l'immagine reale della finitura.

* B: Wengé RW | M: Spa Prestige 2202

Memory foam mattress included / Materasso memory foam incluso

Focus on

- 3 electric motors for height, backrest and legrest adjustment
- Standard pedal control with 2 options for MEMORY function
- AUT function: automatic return from any position to zero position (flat and minimum height)
- END function: "End of treatment" position
- Double column in curved wood and base in painted steel
- Standard memory foam mattress with HBS Stress Relief System which provides perfect ergonomics for client's head, back and shoulders
- Fire resistant "Azo" free, anti-bacterial and anti-fungal covering
- Multifunctional solution, maximum customer / operator comfort

- 3 motori elettrici per regolazione di altezza, schienale e poggiatesta
- Pedaliera standard con 2 opzioni di funzione MEMORIE
- Funzione AUT: ritorno automatico da ogni posizione alla posizione zero (piatto e altezza minima)
- Funzione END: posizione "fine del trattamento"
- Doppia colonna in legno curvato e base in acciaio verniciato
- Materasso standard con memory foam e Sistema Anti Stress HBS che garantisce perfetta ergonomia per testa, spalle e schiena
- Rivestimento ignifugo, "Azo" free, antibatterico, antimicotico
- Soluzione multifunzionale, massimo comfort cliente / operatore

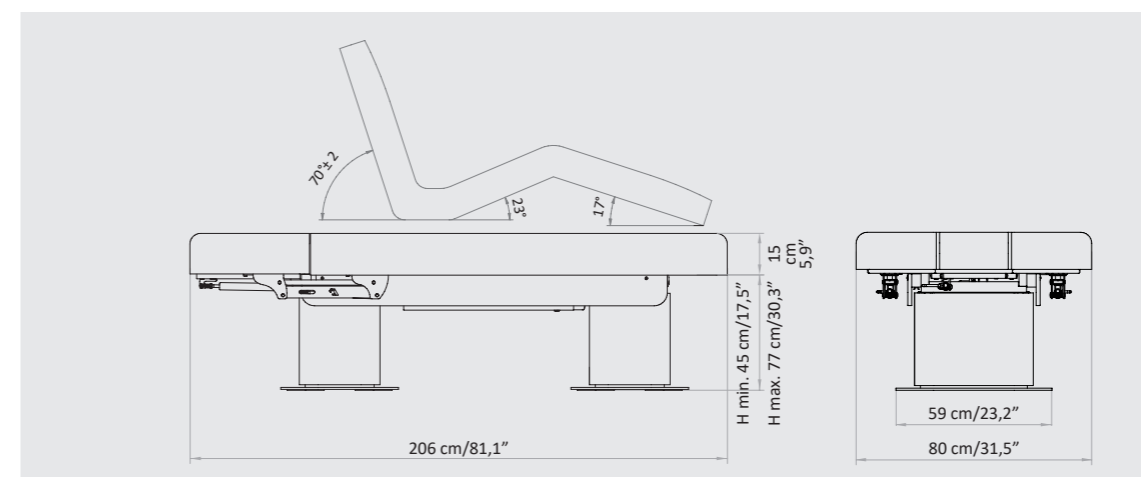

Packaging details

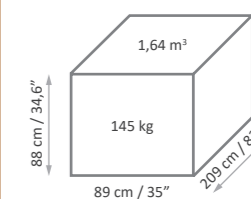

MAXIMUM CAPACITY
PORTATA MASSIMA
200 kg

MATTRESS CUSTOMIZATION PERSONALIZZAZIONE MATERASSO

VITA - COLOR CHART



SPA PRESTIGE - COLOR CHART



NEFOS - COLOR CHART



MATTRESS THICKNESS SPESSORE MATERASSO



SUPER SOFT - 15 CM / 6" with Memory Foam
 Super soft mattress with memory foam, available
 ONLY for 74 cm / 29,1" and 82 cm / 32,3" width
 Materasso super soft con memory foam, disponibile
 SOLO per larghezze 74 cm e 82 cm

MATTRESS WIDTH LARGHEZZA MATERASSO

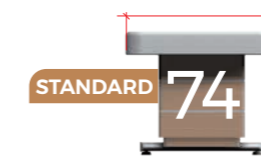

S - 74 CM / 29,1"
 Standard Width - 74 cm / 29,1"
 Larghezza Standard - 74 cm / 29,1"

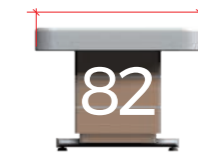

M - 82 CM / 32,3"
 Medium Width - 82 cm / 32,3"
 Larghezza Medium - 82 cm / 32,3"

The innovative VITA (consisting of 80% natural and renewable components), Spa Prestige and Nefos materials - which are exclusive for LEMI products - and their special finishing touch guarantee easy-cleaning and hygiene. Their extraordinary structural qualities will persist through the years. An incredibly elastic texture enhances the memory foam mattress softness and quality at its best, giving Spa Clients a complete and satisfying wellness experience.

Gli innovativi materiali VITA (costituiti per l'80% da componenti naturali e rinnovabili), Spa Prestige e Nefos - che sono un'esclusiva dei prodotti LEMI - ed il loro speciale tocco di finitura garantiscono una facile pulizia e igiene. Le loro straordinarie qualità strutturali permangono nel corso degli anni. Una texture incredibilmente elastica migliora al massimo la morbidezza e la qualità del materasso in Memory Foam, dando ai clienti Spa un'esperienza di benessere completa e soddisfacente.

The images are for illustrative purposes only and may not reflect the actual finish of the product, particularly when viewed through a screen. Therefore, the **SELECTION OF THE FINISHES** of the **BASES** and **MATTRESS FABRICS** must take place **AFTER CONSULTING** the **LUXURY BOX PHYSICAL SAMPLES** and the **COLOR CHARTS**.

Le immagini hanno valore puramente illustrativo e possono non rispecchiare la finitura reale del prodotto, in particolare se visualizzate attraverso uno schermo. Pertanto la **SELEZIONE DELLE FINITURE** delle **BASI** e dei **RIVESTIMENTI** dei **MATERASSI** deve avvenire **PREVIA CONSULTAZIONE** della **CAMPIONATURA FISICA** della **LUXURY BOX** e delle **CARTELLE COLORI**.

BASE CUSTOMIZATION PERSONALIZZAZIONE BASE

SIRIO - FINISHES CHART

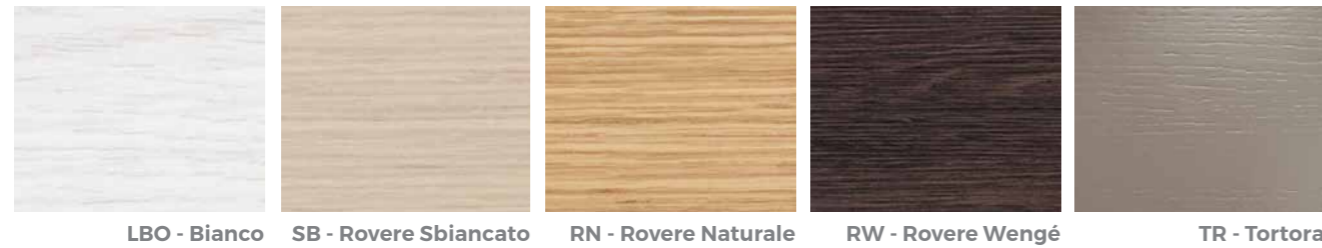

Today, 70% of the company's wooden equipment and treatment tables are manufactured using FSC certified lumber from unprotected forests. The woods are furnished by suppliers that have committed themselves to sustainable development, guaranteeing full compliance with the best environmental protection practices.

Oggi, il 70% delle attrezzature e dei lettini in legno dell'azienda sono realizzati con legname certificato FSC proveniente da foreste non protette. I legni provengono da fornitori che si sono impegnati per lo sviluppo sostenibile, garantendo il pieno rispetto delle migliori pratiche di tutela ambientale.

The images are for illustrative purposes only and may not reflect the actual finish of the product, particularly when viewed through a screen. Therefore, the **SELECTION OF THE FINISHES** of the **BASES** and **MATTRESS FABRICS** must take place **AFTER CONSULTING** the **LUXURY BOX PHYSICAL SAMPLES** and the **COLOR CHARTS**.

Le immagini hanno valore puramente illustrativo e possono non rispecchiare la finitura reale del prodotto, in particolare se visualizzate attraverso uno schermo. Pertanto la **SELEZIONE DELLE FINITURE** delle **BASI** e dei **RIVESTIMENTI** dei **MATERASSI** deve avvenire **PREVIA CONSULTAZIONE** della **CAMPIONATURA FISICA** della **LUXURY BOX** e delle **CARTELLE COLORI**.

ACCESSORIES UPON REQUEST ACCESSORI SU RICHIESTA

All tables have a standard setting customizable upon request.

Tutti i lettini hanno una configurazione standard personalizzabile su richiesta.



Oil-resistant protection
Proteggi materasso resistente agli oli



Luxury "Dreamsoft" cover
Coprilettino Dreamsoft



Rotating Evo armrest couple
Coppia braccioli girevoli Evo



Luxury towel
Telo Deluxe



Color therapy
Cromoterapia



Handset control with memories
Pulsantiera con memorie



Wireless foot pedal control with memories
Pedaliera wireless con memorie



Heating system
Riscaldamento



UK cable
Cavo UK



USA cable
Cavo USA



Disposable EVO Headrest cover (pack 100 pcs.)
Copritesta EVO monouso (confezione 100 pz.)



Plastic leg protection
Protezione gambe in plastica



Customized mattress with logo
Personalizzazione materasso con logo

LEMI MATTRESSES STANDARD

Each mattress is HANDCRAFTED, therefore the ACTUAL MEASUREMENTS MAY VARY from those indicated in the catalogue by approximately ± 1 cm (also based on the selected configuration).



EVO LINE - STANDARD

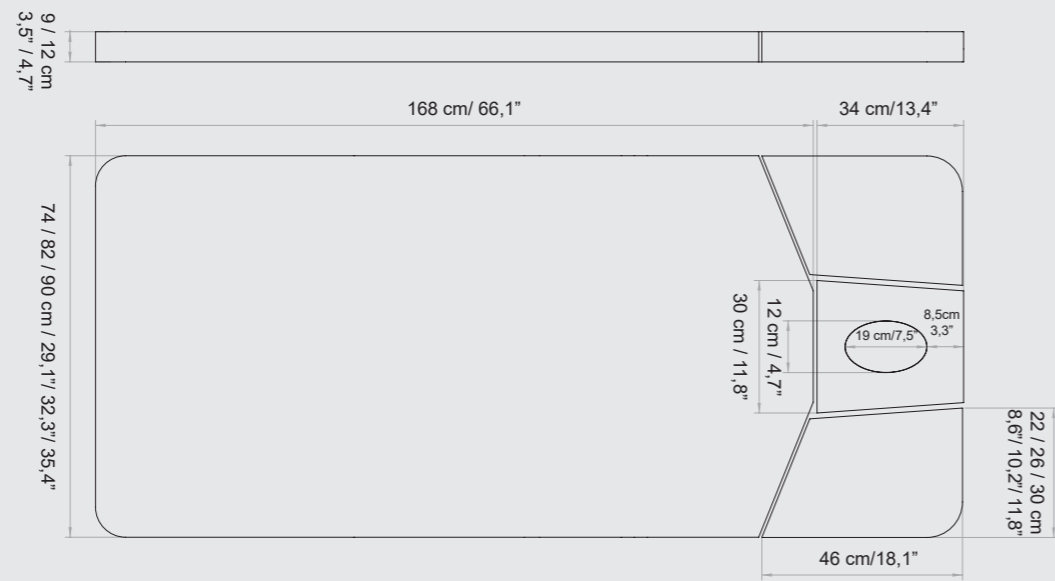

AVAILABLE FOR WIDTH / DISPONIBILE PER LARGHEZZA: 74 / 82 / 90 CM

MATERASSI LEMI MEMORY

Ogni materasso è realizzato A MANO, pertanto le MISURE REALI POTREBBERO VARIARE rispetto a quelle indicate nel catalogo di circa ± 1 cm (anche in base alla configurazione selezionata).

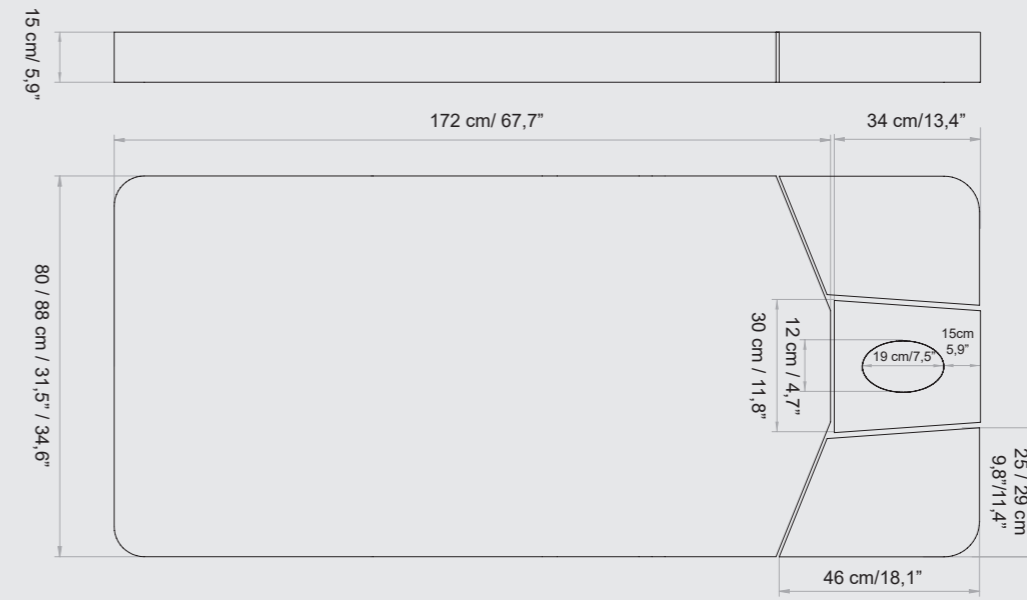

AVAILABLE FOR WIDTH / DISPONIBILE PER LARGHEZZA: 74 / 82 CM



EVO LINE - MEMORY



VERONA EVO - STANDARD

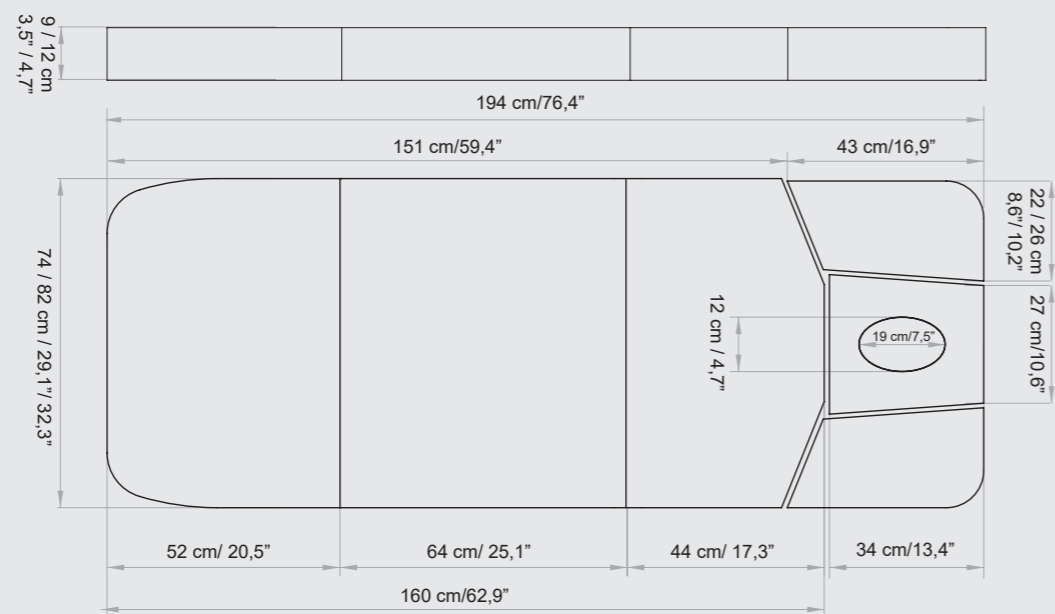

AVAILABLE FOR WIDTH / DISPONIBILE PER LARGHEZZA: 74 / 82 CM

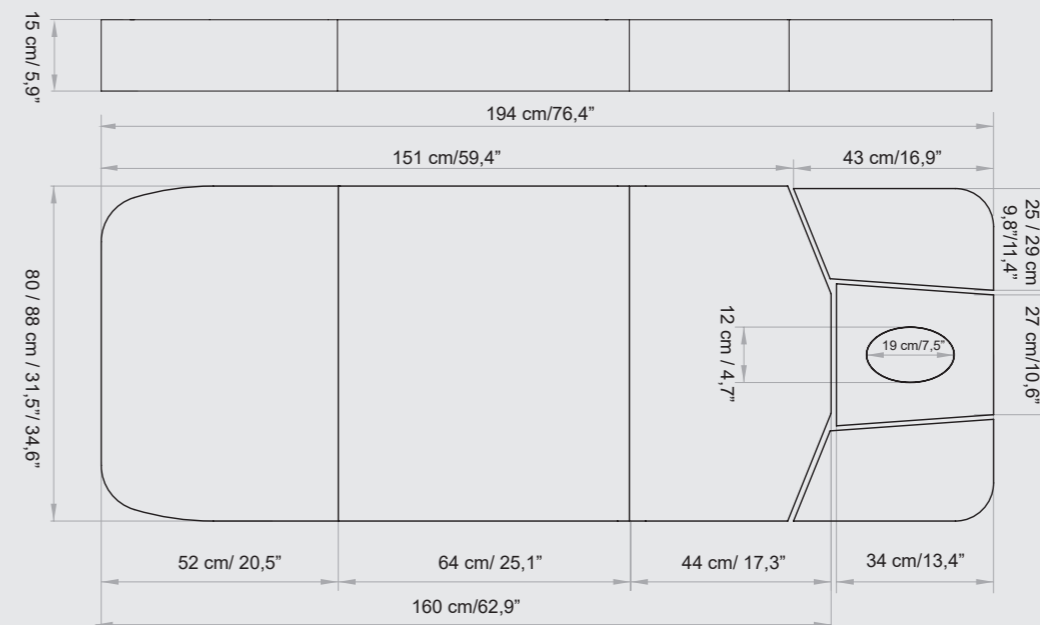

AVAILABLE FOR WIDTH / DISPONIBILE PER LARGHEZZA: 74 / 82 CM



VERONA EVO - MEMORY

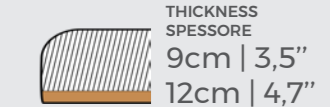

TECHNICAL REQUIREMENTS

CARATTERISTICHE TECNICHE

ABSORPTION ASSORBIMENTO	VOLTAGE VOLTAGGIO	POWER POTENZA	FREQUENCY FREQUENZA	WARRANTY	GARANZIA
4 Amax (1,7 A)	100 Vac (240Vac)	250W	50/60 Hz	<i>Mattress heating: 1 year</i> <i>Electric parts and controls: 3 years</i> <i>Undeformable foam: 5 years</i> <i>Actuators: 5 years</i> <i>Structure: Lifetime</i>	Riscaldamento materasso: 1 anno Parti elettriche e comandi: 3 anni Gomma indeformabile: 5 anni Attuatori: 5 anni Struttura: a vita

REGULATIONS

All Equipment is **CE** marked

Electrical equipment and beds

Directive 2006/42/CE (Machinery Directive) and national regulations

Directive 2014/30/UE (Electromagnetic Compatibility Directive) and national regulations.

Images

The images are for illustrative purposes only and may not reflect the actual image of the product.

NORME

Tutte le attrezzature sono a marchio **CE**

Attrezzature e lettini elettrici

Direttiva 2006/42/CE (Direttiva Macchine) e disposizioni nazionali di attuazione

Direttiva 2014/30/UE (Direttiva Compatibilità elettromagnetica) e disposizioni nazionali di attuazione.

Immagini

Le immagini hanno valore puramente illustrativo e possono non rispecchiare l'immagine reale del prodotto.

Lemi[®]
ITALIAN WELLNESS EQUIPMENT

Brusaferrì & C srl

Via Mara Maretti Soldi, 13
26011 Casalbuttano (CREMONA) ITALY
Phone +39-0374-363069 Fax +39-0374-363071
info@lemigroup.it service@lemigroup.it

www.lemigroup.it