

STOOL 035/S

COD. 035/S

High stool for make-up with gaslift regulation

Specially designed stools for the beauty sector, ideal for guaranteeing the maximum comfort of professionals who perform manicures, pedicures and aesthetic facial treatments. The stools come complete with a gas-pump height adjustment.

Sgabello alto per make-up con regolazione gaslift

Sgabelli appositamente progettati per il settore beauty, ideali per garantire il massimo comfort ai professionisti che eseguono manicure, pedicure e trattamenti estetici del viso. Gli sgabelli sono completi di regolazione dell'altezza tramite pompa a gas.



INCLUDED

Gray plastic base / Base plastica grigia

Adjustable backrest / Schienale regolabile

Footrest ring / Anello poggia piedi

Saddle seat / Seduta a sella

ON DEMAND



Aluminium base Ø50 cm / 19,6"

Base alluminio Ø50 cm

STOOL 035/S – Dimensions / Dimensioni

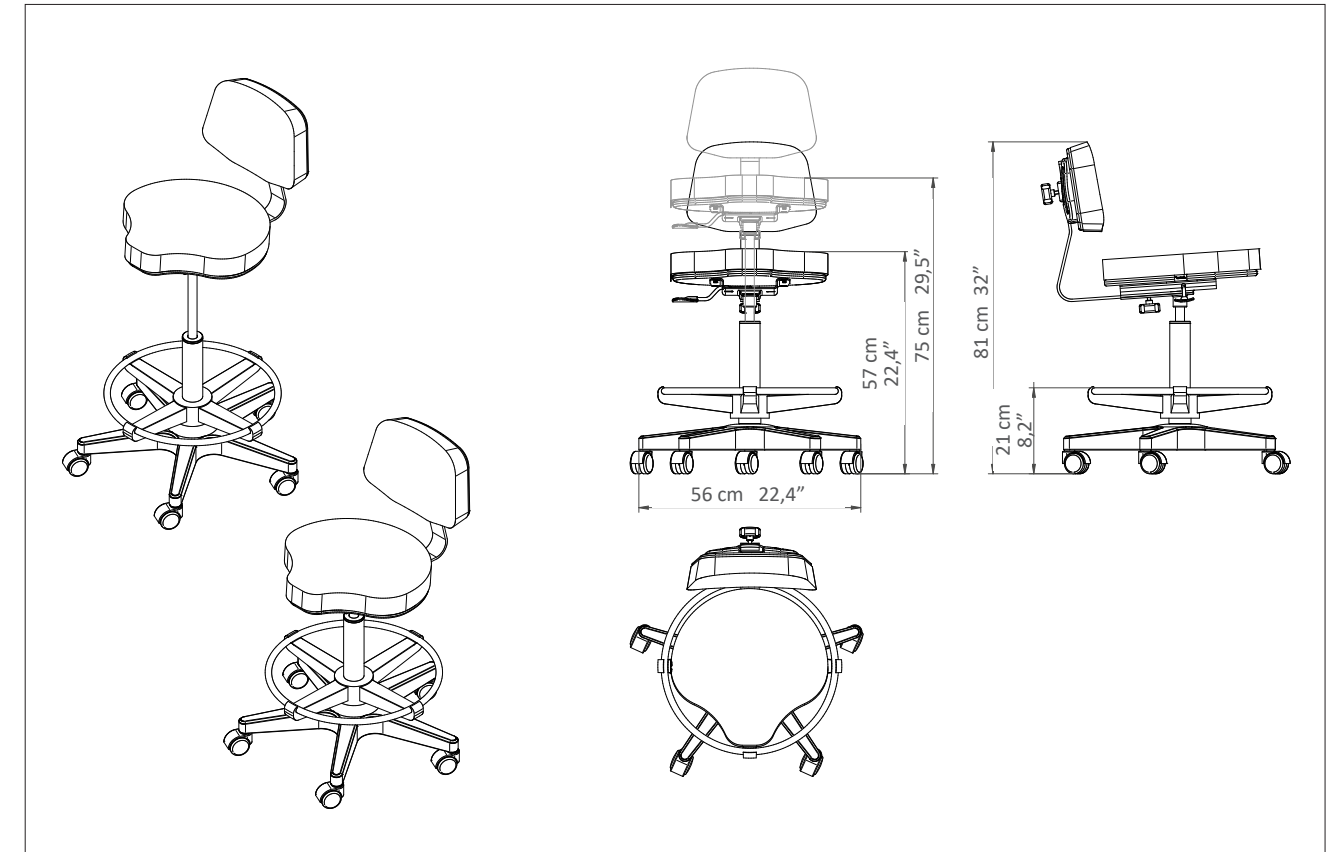

STOOL 035/S – Technical Requirements / Caratteristiche tecniche

Height / Altezza	Diameter / Diametro	Warranty / Garanzia
<i>Height min - 57 cm 22,4" Height max - 75 cm 29,5"</i>	<i>Base Ø - 56 cm 22" Seat Ø - 40 cm 15,7"</i>	<i>Structure and gaslift adjustment: 2 years Undeformable foam: 5 years</i>
<i>Altezza min - 57 cm Altezza max - 75 cm</i>	<i>Base Ø - 56 cm Seduta Ø - 40 cm</i>	<i>Struttura e regolazione gaslift: 2 anni Gomma indeformabile: 5 anni</i>

MATTRESS CUSTOMIZATION PERSONALIZZAZIONE MATERASSO



VITA - COLOR CHART

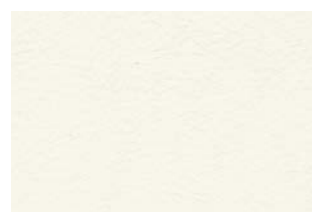

EV00021

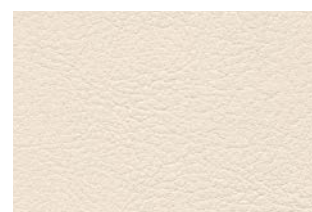

EV00022



EV00041



EV00042

SPA PRESTIGE - COLOR CHART



9916

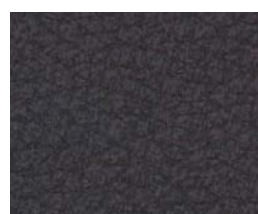

1424

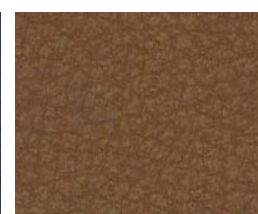

1423

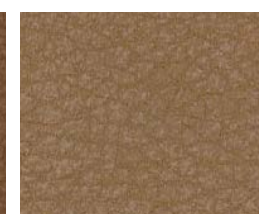

1422

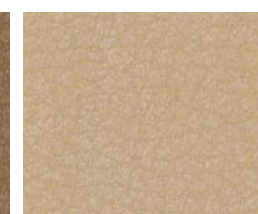

2202



2204



7022



7023



1875



1530

NEFOS - COLOR CHART



6



1957



6985



3962

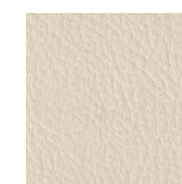

1155

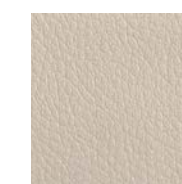

2124



1194



2173



6986



569



667

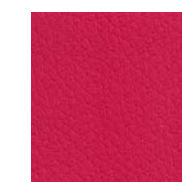

680



64



71

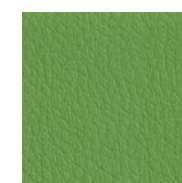

1868



1843

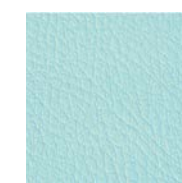

8019



8009



5946

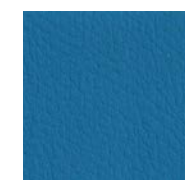

6940



6941



6942



1388

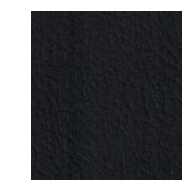

991

The innovative VITA (consisting of 80% natural and renewable components), Spa Prestige and Nefos materials - which are exclusive for LEMI products - and their special finishing touch guarantee easy-cleaning and hygiene. Their extraordinary structural qualities will persist through the years. An incredibly elastic texture enhances the memory foam mattress softness and quality at its best, giving Spa Clients a complete and satisfying wellness experience.

Gli innovativi materiali VITA (costituiti per l'80% da componenti naturali e rinnovabili), Spa Prestige e Nefos - che sono un'esclusiva dei prodotti LEMI - ed il loro speciale tocco di finitura garantiscono una facile pulizia e igiene. Le loro straordinarie qualità strutturali permangono nel corso degli anni. Una texture incredibilmente elastica migliora al massimo la morbidezza e la qualità del materasso in Memory Foam, dando ai clienti Spa un'esperienza di benessere completa e soddisfacente.

The images are for illustrative purposes only and may not reflect the actual finish of the product, particularly when viewed through a screen. Therefore, the **SELECTION OF THE FINISHES** of the **MATTRESS FABRICS** must take place **AFTER CONSULTING** the **PHYSICAL SAMPLES** of the **COLOR CHARTS**.

Le immagini hanno valore puramente illustrativo e possono non rispecchiare la finitura reale del prodotto, in particolare se visualizzate attraverso uno schermo. Pertanto la **SELEZIONE DEI RIVESTIMENTI** dei **MATERASSI** deve avvenire **PREVIA CONSULTAZIONE** della **CAMPIONATURA FISICA** delle **CARTELLE COLORI**.

REGULATIONS

All Equipment is **CE** marked

NORME

Tutte le attrezzature sono a marchio **CE**

Lemi
ITALIAN WELLNESS EQUIPMENT

Brusaferrri & C srl

Via Mara Maretti Soldi, 13 - 26011 Casalbuttano (CREMONA) ITALY

Phone +39-0374-363069 Fax +39-0374-363071

info@lemigroup.it service@lemigroup.it www.lemigroup.it