

Where
design
meets
quality

Zeta

NAMRØL
GROUP





Zeta

Namrol is shaping the future of professional podiatry chairs.

All research begins with a consideration of history. Using the example of our 1995 podiatry chair, designers describes those elements that still make a Namrol chair unmistakable today. A combination of precision and technological innovation, Zeta offers a patient chair in a class of its own.

The design of Zeta chair really stands out from the crowd. It showcases individuality, while also impressively demonstrating how progress can be interpreted in a comfort way.

The reference
for all new
Namrol designs.







Zeta

You choose 3, 4 or 5 motors

Podiatry Chairs are an essential part of a practice and should be the focal point of every clinic.

More than just a necessary piece of equipment, Zeta represent an investment in quality, technology, and comfort to your patients. It's the opportunity for your podiatry clinic to enhance efficiency and expand treatment solutions, differentiating your practice and clearing the way for profit growth.



skai®

Ideal cover for intensive use

High quality skai® material with fine calf leather grain and subdued matte-gloss-effect.

Disinfectant resistant.

Fulfills medical standard DIN EN ISO 10993-5+10.

Long-lasting.

Easy to clean.

Tear resistant.

Blood- and urine resistant .



LINAK® 
WE IMPROVE YOUR LIFE

High Performance and Control

Low-noise durable and powerful actuators, with high speed/ high performance and mechanical endstop for first failure safety. This makes it the right choice for the future.



SENOSAN

High quality material made of ABS and PMMA.

White coextruded multi-layer composite sheet with a brilliant surface of sanitary acrylic. High chemical resistance, high impact strength, long durability and of course recyclable.



STABILUS

Variable Positioning

A special piston / valve system, which separates the two pressure chambers in the spring, allows effortless movement and locking.

Details make the difference

It's just a small thing that most people wouldn't notice, but it's a detail worth noting in the quest for outstanding quality and durability.

Uncompromising approach to every treatment situation.

Let us help you choose a Zeta chair that will take your clinic to a whole new level.



Zeta can reach a perfect flat position at any height, for the maximum comfort of the operator while performing a clinical examination or professional treatment.



The swivel base, the minimum height to the floor and the folding arms, provide comfortable access for the patient.



Anatomical backrest with low hardness foam, for comfortable and relaxed treatment of patients.



Powered base, back and tilt for effortless positioning (Zeta 3)

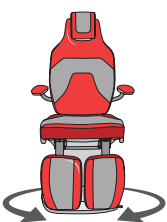

360° rotation on base enabling different working positions.

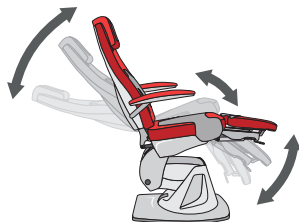

Powered base, back and tilt for effortless positioning.

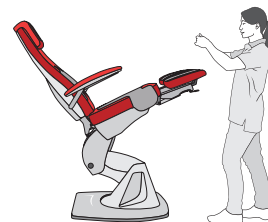

Maximum height of 140 cm allows you to work standing if desired.

What's your ideal Zeta?

Technical details	Zeta 3	Zeta 4	Zeta 5
Ref. Dual leg	SN-717	SN-718	SN-719
Ref. Single leg	SN-727	SN-728	-----
Number of actuators	3	4	5
Power connection	230/115 VAC	230/115 VAC	230/115 VAC
Frecuency	50 / 60 Hz	50 / 60 Hz	50 / 60 Hz
Watt	300 W	300 W	300 W
Standby power	Approx. 0.5 W	Approx. 0.5 W	Approx. 0.5 W
Memories	2	2	2
Warranty	5 years	5 years	5 years

Movements

Height adjustment	Electrical	Electrical	Electrical
Seat adjustment	Electrical	Electrical	Electrical
Back adjustment	Electrical	Electrical	Electrical
Legrest adjustment	Gas spring	Electrical at once	Electrical independently
Legrest hand controls	x	x	✓

Weights

Lifting capacity	220 Kg	220 Kg	220 Kg
Weight	97 Kg.	97 Kg.	97 Kg.

Dimensions

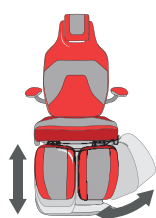
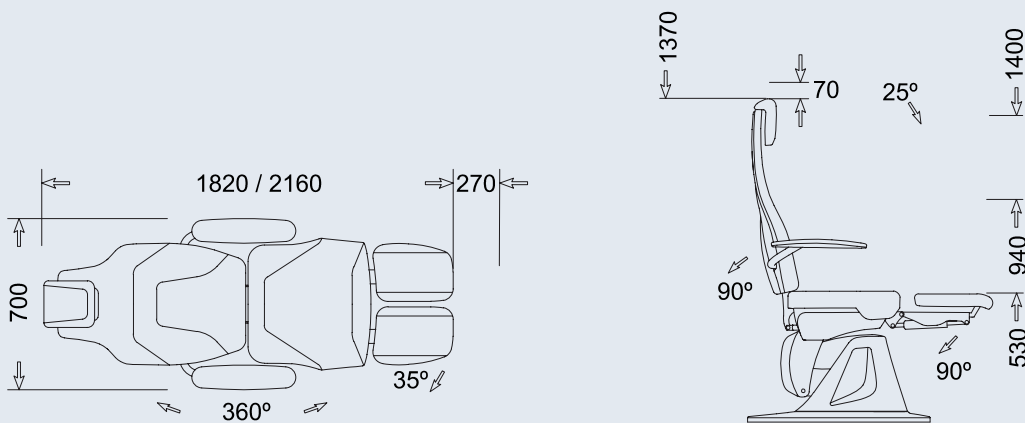

Two piece, dual leg supports are operated by gas spring and can be extended for taller patients.

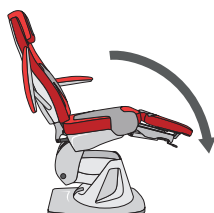

Patented anti tip system helps to prevent movement when the patient enters or exits the chair.

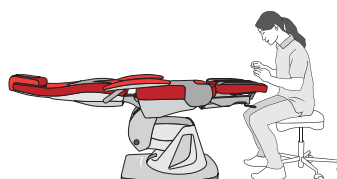

Small base footprint which takes up less space in treatment room.

Top features

ZETA Chair



Comfort begins at the head

Make yourself and your patients comfortable. Adjust the headrest of your Zeta chair exactly to the comfort position. The fixed positions are precisely adapted to the anatomy.



Hands free operation

The foot switch is your multifunctional control element for all chair functions. Include home position and two memory positions that you customize to your needs.



Quick adjustment

Easy-to-reach release handles on side of each legrest allow for smooth, one-handed operation . (Electrical movement in Zeta 5)



Padded access

The exclusive seat design with side padded, ensures comfortable access for everyone and enable patients to transfer onto and off of the chair with minimal assistance.

Top features

ZETA Chair



Single leg

Single leg support which is electrically operated. SN-727 and SN-728



360°

360° Rotation with foot lever for a perfect and controlled locking function



Easy to get into and out of the chair

Upholstered arms make it easier for your patients to get into and out of the chair. They swing downwards and provide support and security during treatment, without you having to forgo freedom of movement. Arms lower with the chair back as well as swivel.



Multi-Positioning

Articulated leg rests with angular width of 30° -30°, mounted on telescopic slides with travel up to 300 mm, tilting and vertically lift able with an amplitude angle by 90°, perfectly vertical to the ground in the rest position.

Accessories, the value of choice

A broad range of accessories lets operator personalise the treatment chair according to their specific needs.



Protection screen

Protection screen can be attached to either side of the chair, is designed to block the patient's line of sight to the foot treatment area.



Paper roll holder

Ergonomic paper holder, easy assembly (max. length 59 cm, 12,5 cm diameter)



Debris tray

Waste collection trays with quick clamping system in stainless steel.



Magnifying lamp support

Chair side mount magnifying lamp support. Synchronized raising and lowering movement with the chair.



Scalytic lamp support

Chair side mount scalytic lamp support. Synchronized raising and lowering movement with the chair.



Hand control

The Zeta handset has an ergonomic design and size and features large buttons all blending in to a user-friendly handset. Hook for placement on the bed.



Wireless Foot Control

Enjoy the freedom of locating the foot control anywhere in the room. Remove cords and eliminate obstacles.

A close-up photograph of a modern office chair. The chair features a vibrant red, upholstered seat with visible stitching along the edges. The frame is a light grey or off-white color, showing a complex, ergonomic design with a large, curved cutout in the backrest area. The background is plain white, emphasizing the chair's form and color.

New generation seats, a fusion of contemporary design with attention to essential ergonomic features. A properly supported back for the professional whilst carrying out his duties.

NAMROL

Stools

Ergonomic for ideal posture.

It's just a small thing that most people wouldn't notice, but it's a detail worth noting in the quest for outstanding quality and durability.



COSMOS

Anatomic stool with backrest, upholstered in SKAY, seamless easy to clean with piston controlled height regulation. Soft double wheels mounted on a chrome finish with 5 support points. Colors can be matched to the range of colors for the treatment beds.



MONZA

Anatomic stool with half moon back rest, upholstered in SKAY, seamless easy to clean with piston controlled height regulation. Soft, double castors mounted on chrome finish, with 5 points of support. Colors can be matched to the range of colors for the treatment beds



CORSA

Ergonomically designed stool to maintain proper posture, upholstered in SKAY seamless, easy to clean with piston controlled height regulation. Soft double wheels mounted on a chrome finish with 5 support points. Colors can be matched to the range of colors for the treatment beds.



CORSA - V

Very healthy, incredibly comfortable "Saddle seat" with backrest. It is possible to adjust the height of the stool through gas spring.



CORSA - L

Very healthy, incredibly comfortable "Saddle seat" with backrest. It is possible to adjust the height of the stool through gas spring.



MONZA - T

It is possible to adjust the height of the stool through gas spring.



Exclusive personality

High-quality skai® material with fine calf leather grain and subdued matte-gloss-effect. The very extensive and trend-orientated color spectrum enables many combinations.



	Long-lasting	✓
	Tear resistant	✓
	Easy to clean	✓
	Abrasion resistance	> 50.000
	Skin irritation and sensitivity ISO 10993-10	No reaction
	Cytotoxicity ISO 10993-5	Complies
	UV resistance	✓
	Composition	90% PVC-compound 10% knitted fabric
	Made in	Germany



The colour samples are indicative and not intended as an exact replica of the actual colour of the product.
The products are subject to modifications and improvements without previous notice.





UPHOLSTERY

Our senses enable us to appreciate quality and aesthetics. Our eyes register every nuanced colour hue. Our hands explore surfaces and textures.

It is this uncompromising perfection which turns Namrol upholstery into an experience for all the senses.



Zeta

NAMRØL
GROUP

C. Drets Humans, 17-19
08870 Sitges · Barcelona · Spain
www.namrol.com
export@namrol.com
Tel. : +34 938 113 688

Distributed by

